



TOYO LED ELECTRONICS LIMITED

<http://www.toyo-led.com>

e-mail: sales@toyo-led.com

PACKAGE DIMENSION

E10802

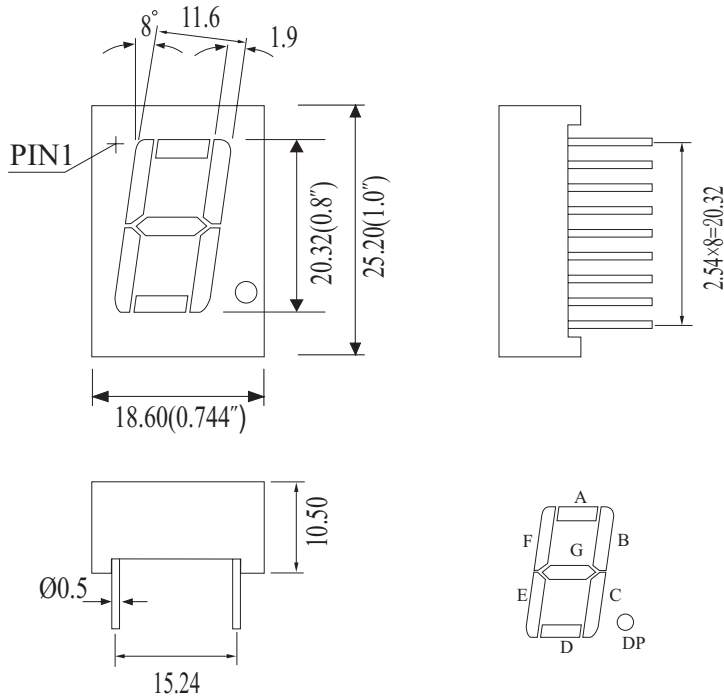

UNIT: MM(INCH) TOLERANCE: $\pm 0.25(0.01)$ "

INTERNAL CIRCUIT DIAGRAM

